

INTERMITTORE-OSCILLATORE INTERMITTENT-OSCILLATING DRIVE AP-OP 85

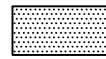

ROTANTE
ROTATING

PESO / Weight

Kg. 27,0

DISPONIBILE SU DISCO CAD
Available on CAD disc

FILE
W40647

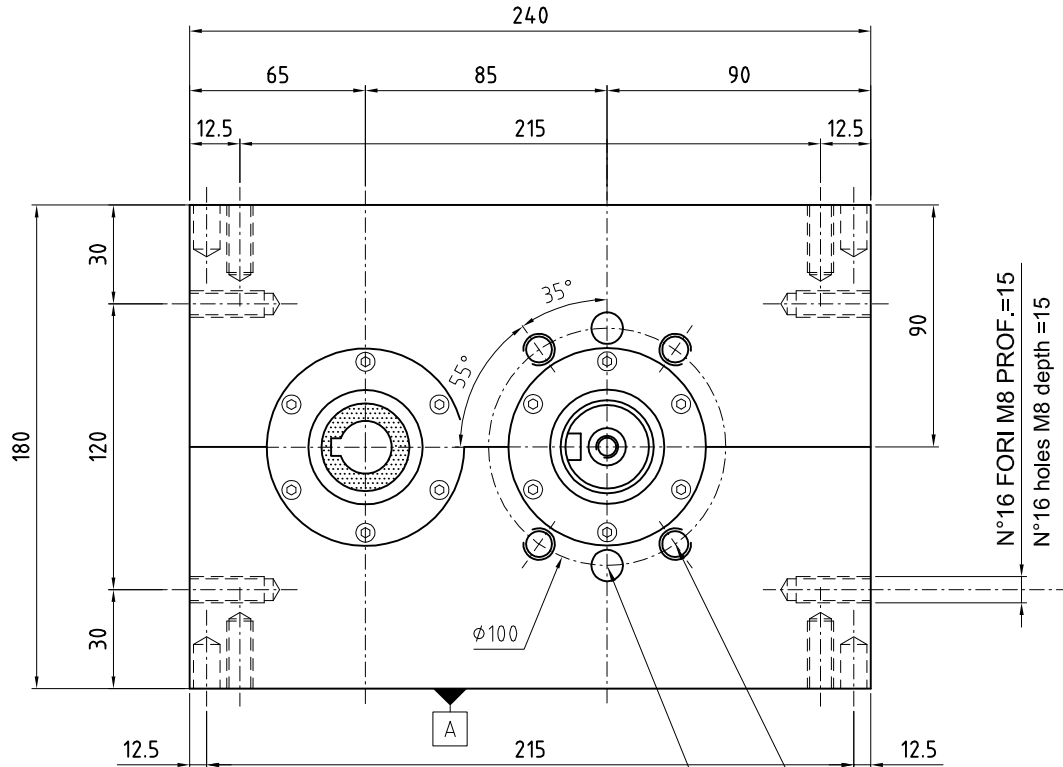

N°16 FORI M8 PROF.=15
N°16 holes M8 depth =15

N°2 FORI Ø 8H7 PROF.=15 ANCHE SU PIANO A
N°2 holes i.d. 8H7 depth = 15 on plane A too

N°4 FORI M10 PROF.=19
N°4 holes M10 depth =19
N°2 FORI Ø10H7 PROF.=22
N°2 holes i.d. 10H7 depth =22

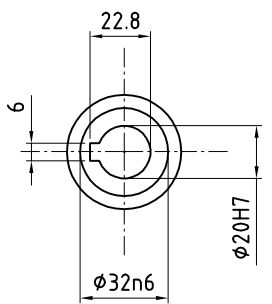
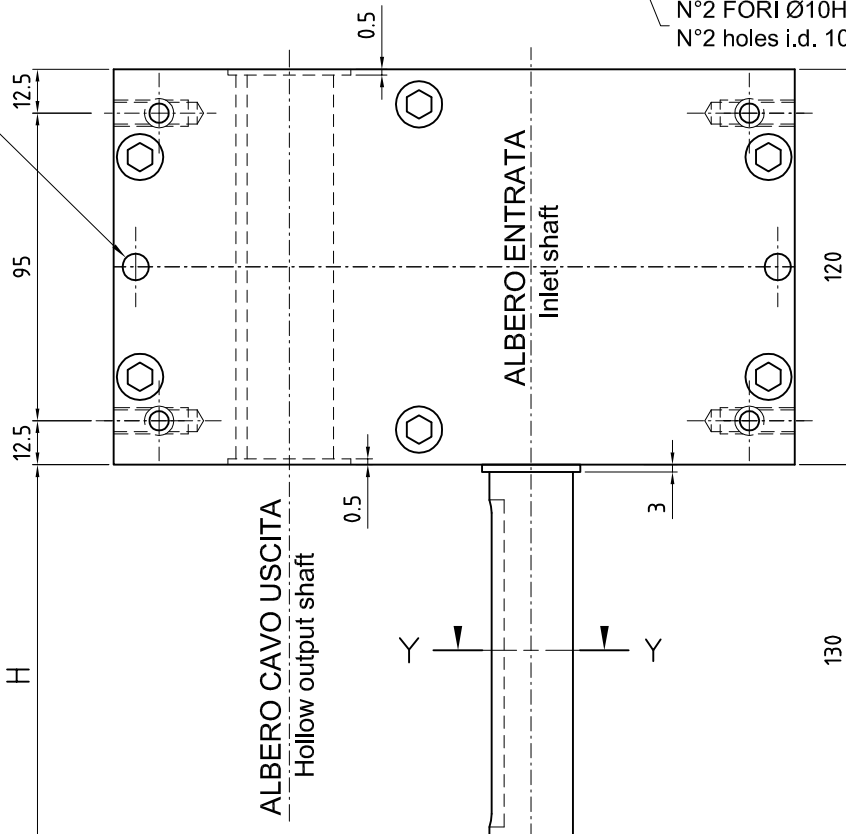

ALBERO CAVO USCITA
Output shaft

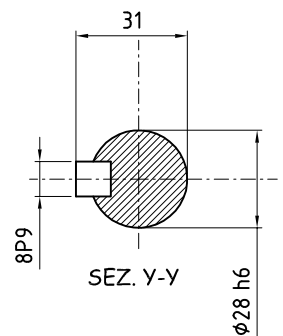

DISTANZA ASSE UNITA' MOTRICE (VEDI CATALOGO)
Power drive unit C.L. distance (see catalog)